

Aantal	Diameter	Buigvorm
6	12	
2	8	
14	8	

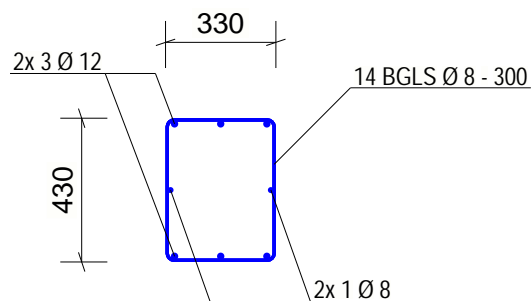
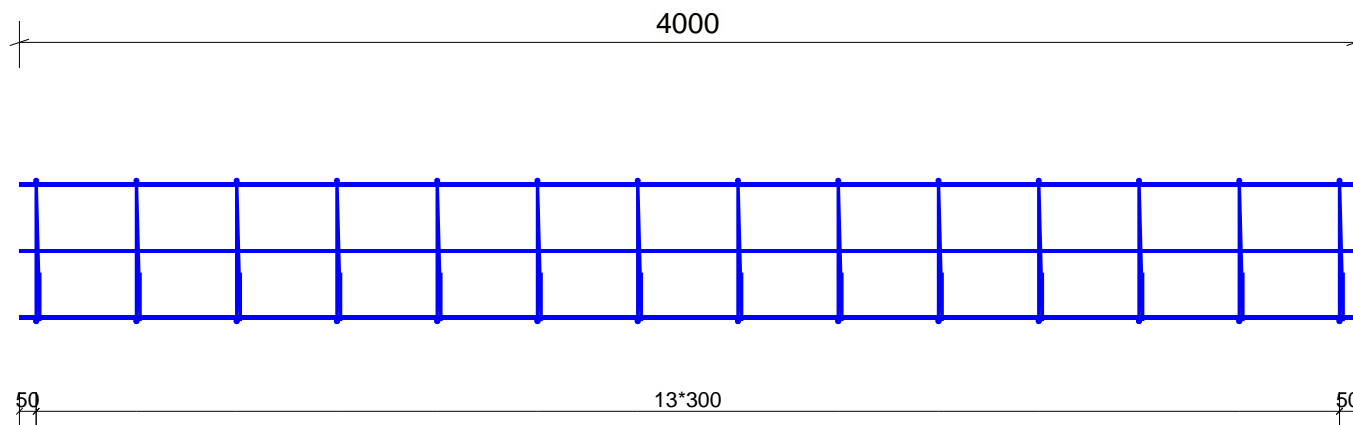

330x430-D12-L4000-T3

PROJECT:

KORF / Ref.:

AANTAL:

GEWICHT: 34.6 kg/stuk

TEKENING:

Montageinstructies



BETONSTAAL.NL  
Tel: 088-0287800  
info@betonstaal.nl